

Rovatti Centrifugal pump cast iron DN50 x DN100 DIN flange green type T2-50 (7024356)



rovatti pompe

TECHNICAL SPECIFICATIONS

Colour green

Material cast iron

Shaft steel

Pump body cast iron

Material impeller 1 cast iron

Connection DIN flange

Max. temperature 60 °C

Impellers 1

Type T2-50

Output Power 50 HP

MWC 102 m

Size DN50 x DN100

Max flow rate 75 m³/h

DIMENSIONS

Cb-1 222 mm

Cr-1 100 mm

G-1 210 mm

H 422 mm

H-1 422 mm

L 474 mm

Mc 120 mm

Mr 253 mm

O 14 mm

W-1 242 mm

ØDi-1 65 mm

ØDi-2 50 mm

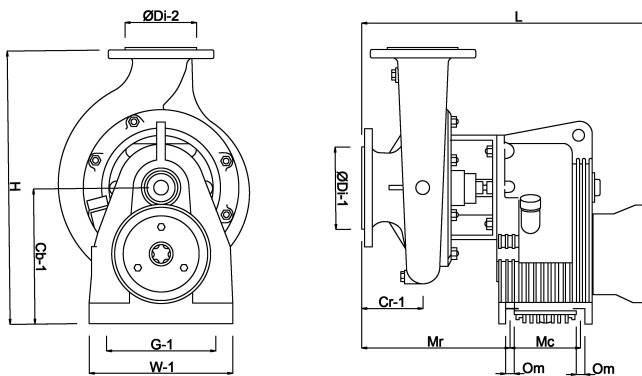

PRODUCT INFORMATION

The tractor driven pumps type T come installed with the "E" impeller which provides the highest pressure. For different impeller types please consult with us.

For the T types, the Standard Gear Ratio (PTO) has been selected. For other Gear Ratios please

consult with us. In order to choose the correct Gear Ratio with the highest efficiency we recommend to have the tractor and torque information upfront.

All the T pumps come with a lattyflon stuffing-box packing which is ideal for dirty water installation. The stuffing-box packing needs to be adjusted accordingly with the Twinner System (2 parts) so it is always leaking in order to keep it lubricated and cool.

No counter flanges are delivered with the T types, for the counter flange kits please consult with us.

The T pumps can also be delivered fully assembled: frame (available in 2 sizes), suction pipe, pressure pipe, manometer, steel valve and hand pump. Please consult with us for more information.

Applications

Medium Pressure Sprinkler Systems: types T1-65A and T2-80.

Medium Pressure Frost Protection: types T3-100A and T4-125 (max 6 and 8 ha. respectively).

High Pressure Hose Rail Machines: types T2-50, T265, T3-80A, T3K80/2 and T4-110.

Last modified date: 08/05/2026

Bosta UK Ltd.

Reflection House

Olding Road

Bury St. Edmunds

Suffolk

IP33 3TA

T +44 (0) 1284 716580

E enquiries@bosta.co.uk

<http://www.bosta.com>