

Norsup Cartridge filter HDPE 2" imperial glue socket 3.5bar grey type ICF530 (7034329)



 **NORSUP 3** YEARS WARRANTY
10 YEARS TANK

TECHNICAL SPECIFICATIONS

Colour	grey
Material	HDPE
Connection	imperial glue socket
Pressure	3.5 bar
Max. temp.	40 °C
Type	ICF530
Capacity	34,5 m ³ /h
Size	2"
Weight	40.8 kg
Filter area	49.1 m ²
Max. pool vol.	190 m ³

DIMENSIONS

A	1223 mm
B	556 mm
C	317.5 mm
D	444.5 mm

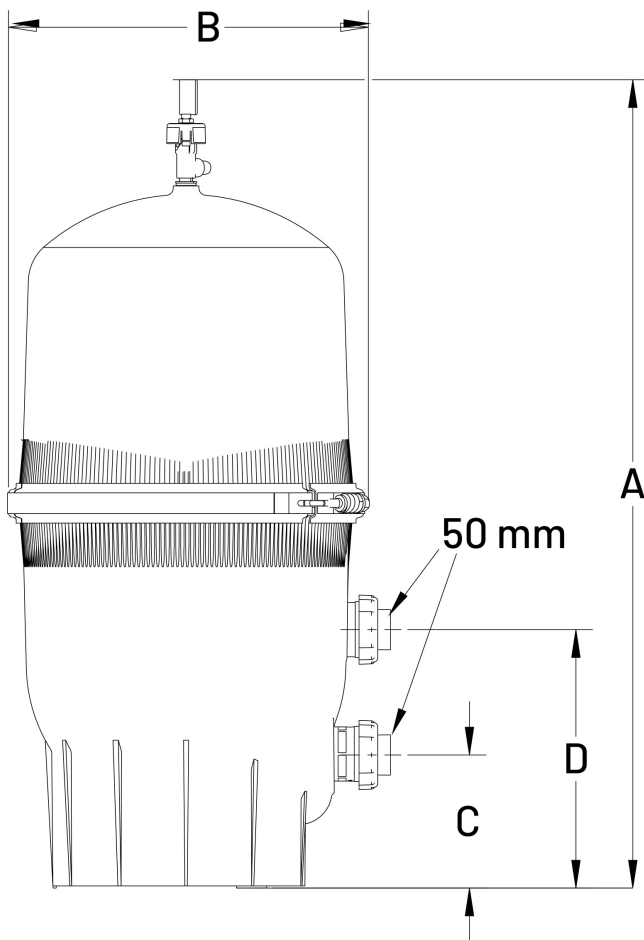

PRODUCT INFORMATION

The Norsup multi-element cartridge filter utilises the latest cartridge filter technology and is constructed with non-corroding, durable material. The filter contains a large filter area, high flow capacity tank and multiple filter elements which provides an unrivalled level of hydraulic debris-catching performance. You can also save precious pool water as the filter does not need to be backwashed.

Features:

- Large flow air relief valve
- Pressure gauge included
- Detachable, easy grip handle
- UV resistant tank with max temperature resistance of 40°C
- 3-way clamp kit allows easy access inside the filter for cleaning & cartridge replacement

- 1.5" bottom drain plug allowing efficient winterisation & simple cleaning & rinsing with a standard garden hose
- Multiple elements provide greater surface area to catch debris keeping pool maintenance to a minimum
- Water saving design with no backwash required
- Ideal in combination with Multicyclone or Norsup UV-C
- 10 years tank warranty

Last modified date: 26/02/2026

Bosta UK Ltd.
Reflection House
Olding Road
Bury St. Edmunds
Suffolk
IP33 3TA
T +44 (0) 1284 716580
E enquiries@bosta.co.uk
<http://www.bosta.com>