

Blindflens RVS 316 DN80 DIN
flens 16bar DN80 PN16
(0080659)



TECHNISCHE SPECIFICATIES

Materiaal RVS 316

Verbinding DIN flens

DIN Norm DIN 2527

Flens PN16

Werkdruk 16 bar

Maat DN80

DN 80

Buiten ø 200 mm

Gewicht 4.6 kg

Dikte 20 mm

Boorgat 18 mm

Gaten 8

AFMETINGEN

PCD 160 mm

O 18 mm

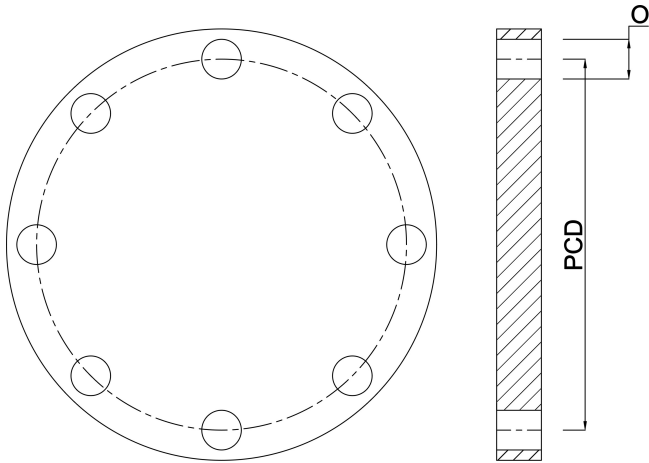

Gegenerereerd op datum: 23-10-2025

<http://www.bosta.com>