

Profec Losflansch PVC-U 225 mm 10bar DN200 Grau PN10 (0110933)



REBER
Bewässerungssysteme

TECHNISCHE DATEN

Farbe Grau

Werkstoff PVC-U

Geeignet für 0110913

Geeignet für 0110913

Maß 225 mm

Bolzen

Verpackung 10 St.

DN 200

Innen ø 250 mm

Flansch PN10

Außen ø 340 mm

Gewicht 1.2 kg

Dicke 32 mm

Arbeitsdruck 10 bar

Loch ø 22 mm

Löcher 8



ABMESSUNGEN

ØDi-1 250 mm

PCD 295 mm

O 22 mm

Db 340 mm

Generiert am: 30.10.2025

Reber Beregnung GmbH
Gottlieb Daimler Str. 2
67227 Frankenthal
32602 VLOTHO-EXTER
Deutschland
+49 (0) 6233 3772 - 0
info@reberberegnung.de
<http://www.reberberegnung.de>

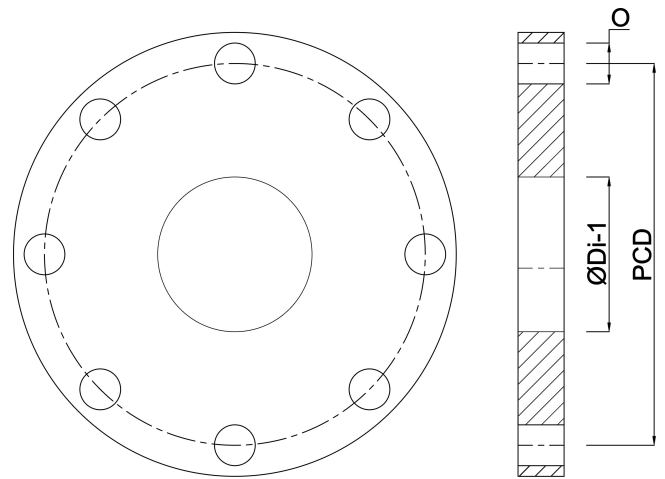

REBER
Bewässerungssysteme