

Profec Losflansch PVC-U 40 mm 16bar DN32 Grau PN10/16 (0110921)



REBER
Bewässerungssysteme

TECHNISCHE DATEN

Farbe Grau

Werkstoff PVC-U

Geeignet für 0110901

Geeignet für 0169838

Maß 40 mm

Bolzen

Verpackung 60 St.

DN 32

Innen ø 51 mm

Flansch PN10/16

Außen ø 143 mm

Gewicht 0.19 kg

Dicke 15 mm

Arbeitsdruck 16 bar

Loch ø 14 mm

Löcher 4



ABMESSUNGEN

ØDi-1	51 mm
PCD	100 mm
O	14 mm
Db	143 mm

Generiert am: 30.10.2025

Reber Beregnung GmbH
Gottlieb Daimler Str. 2
67227 Frankenthal
32602 VLOTHO-EXTER
Deutschland
+49 (0) 6233 3772 - 0
info@reberberegnung.de
<http://www.reberberegnung.de>

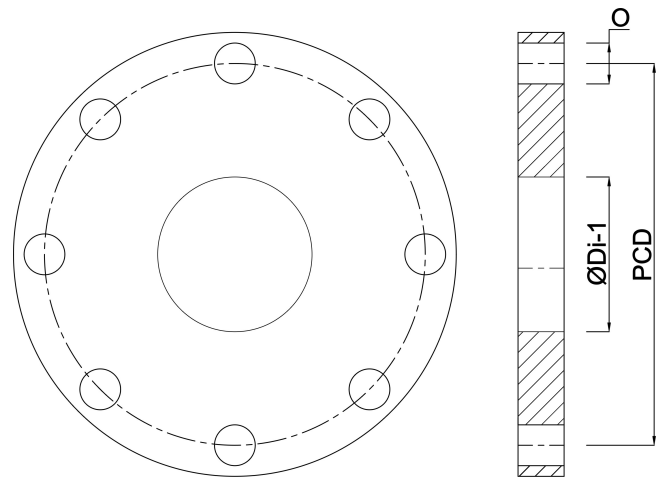

REBER
Bewässerungssysteme