

VDL T-Stück 45° PVC-U 75 mm Klebemuffe 10bar Grau (7018119)



VL Van de Lande



REBER
Bewässerungssysteme

TECHNISCHE DATEN

Farbe Grau

Werkstoff PVC-U

Maß 75 mm

Anschluss Klebemuffe

Arbeitsdruck 10 bar

ABMESSUNGEN

L 207 mm

ØDi-1 75 mm

ØDi-2 75 mm

ØDi-3 75 mm

Ct-1 146 mm

Cr-1 146 mm

P-1 44 mm

P-2 44 mm

P-3 44 mm

β 45 °



Generiert am: 05.11.2025

Reber Beregnung GmbH
Gottlieb Daimler Str. 2
67227 Frankenthal
Deutschland
+49 (0) 6233 3772 - 0
info@reberberegnung.de
<http://www.reberberegnung.de>

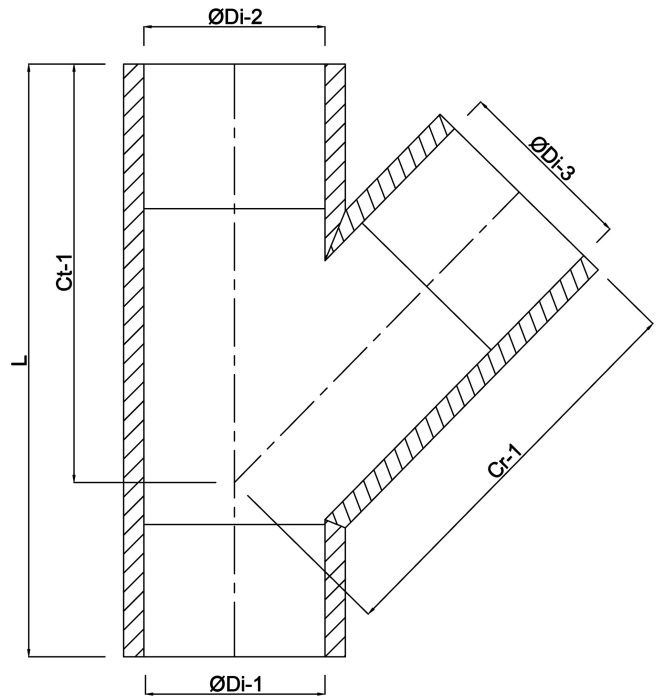

REBER
Bewässerungssysteme