

**Profec Verschraubung PVC-  
U/Edelstahl 316 40 mm x 1 1/4"  
Klebemuffe x Innengewinde  
10bar Grau (0102103)**



**REBER**  
Bewässerungssysteme

# TECHNISCHE DATEN

Farbe	Grau
Werkstoff	PVC-U/Edelstahl 316
Material Dichtung	EPDM
Anschluss	Klebmuffe x Innengewinde
Arbeitsdruck	10 bar
Maß	40 mm x 1 1/4"

# ABMESSUNGEN

L	65.2 mm
ØDi-1	40 mm
ØDi-2	1 1/4 "

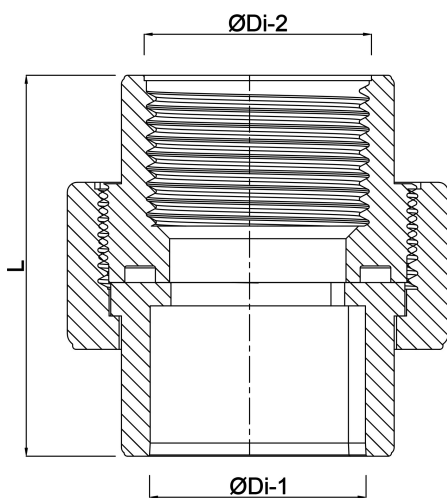

**Generiert am: 24.10.2025**

Reber Beregnung GmbH  
Gottlieb Daimler Str. 2  
67227 Frankenthal  
32602 VLOTHO-EXTER  
Deutschland  
+49 (0) 6233 3772 - 0  
[info@reberberegnung.de](mailto:info@reberberegnung.de)  
<http://www.reberberegnung.de>



**REBER**  
Bewässerungssysteme