

**Profec Winkel 90° PVC-U 32
mm x 1" Klebemuffe x
Innengewinde 10bar Grau
(0110162)**



REBER
Bewässerungssysteme

TECHNISCHE DATEN

Farbe	Grau
Werkstoff	PVC-U
Anschluss	Klebmunne x Innengewinde
Arbeitsdruck	10 bar
Maß	32 mm x 1"

ABMESSUNGEN

ØDi-2	32 mm
ØDi-1	1 "
Cb-1	38 mm
Cb-2	38 mm

Generiert am: 30.10.2025

Reber Beregnung GmbH
Gottlieb Daimler Str. 2
67227 Frankenthal
32602 VLOTHO-EXTER
Deutschland

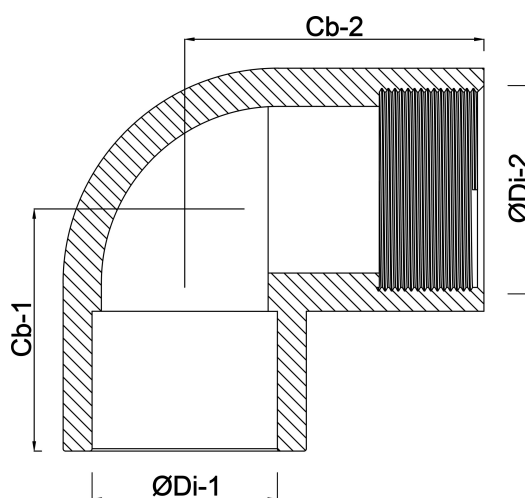

REBER
Bewässerungssysteme

+49 (0) 6233 3772 - 0
info@reberberegnung.de
<http://www.reberberegnung.de>



REBER
Bewässerungssysteme