

Hydro-S Absperrklappe PVC-U
250 mm DIN Flansch 6bar
DN250 Grau PN10 Typ 7500
(7014387)



hydro-s



REBER
Bewässerungssysteme

ABMESSUNGEN

W-1 114 mm

PCD 350 mm

Ct-1 309 mm

R 410 mm

W-2 156 mm

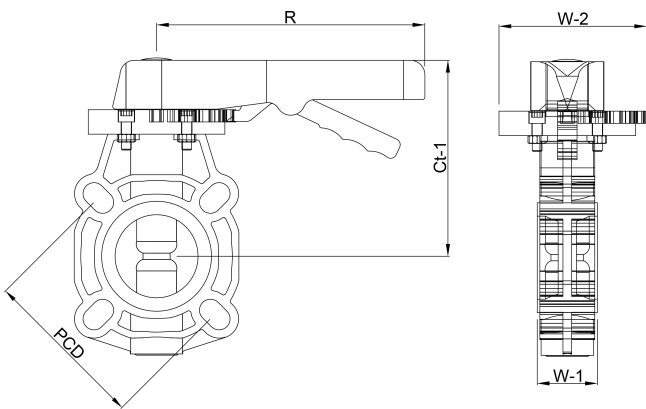

Generiert am: 06.11.2025

Reber Beregnung GmbH
Gottlieb Daimler Str. 2
67227 Frankenthal
Deutschland
+49 (0) 6233 3772 - 0
info@reberberegnung.de
<http://www.reberberegnung.de>



REBER
Bewässerungssysteme