

Profec Losflansch PVC-U 63 mm 16bar DN50 Grau PN10/16 (0110923)



REBER
Bewässerungssysteme

ABMESSUNGEN

ØDi-1	78 mm
PCD	125 mm
O	18 mm
Db	165 mm

Generiert am: 30.10.2025

Reber Beregnung GmbH
Gottlieb Daimler Str. 2
67227 Frankenthal
32602 VLOTHO-EXTER
Deutschland
+49 (0) 6233 3772 - 0
info@reberberegnung.de
<http://www.reberberegnung.de>

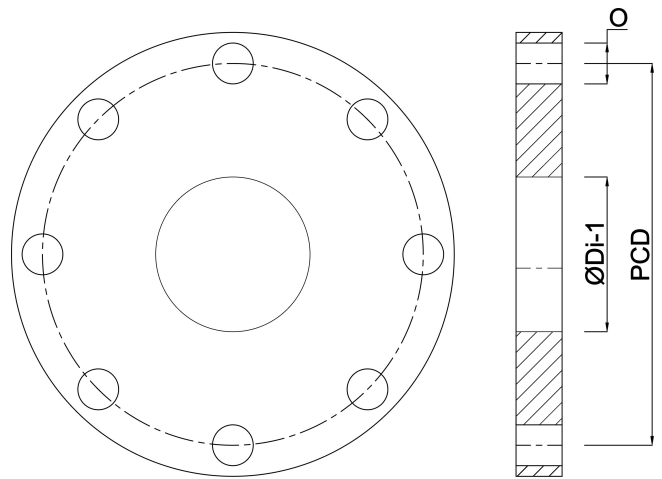

REBER
Bewässerungssysteme