

Profec Nr. 121 Winkel 45°
Edelstahl 316 3/8"
Innengewinde x
Außengewinde 10bar
(0081242)



REBER
Bewässerungssysteme

TECHNISCHE DATEN

Werkstoff	Edelstahl 316
Anschluss	Innengewinde x Außengewinde
Fitting Nr.	Nr. 121
Arbeitsdruck	10 bar
Maß	3/8"

ABMESSUNGEN

$\varnothing Di-1$	3/8 "
$\varnothing Do-2$	3/8 "
Cb-1	18 mm
Cb-2	30 mm
β	45 °

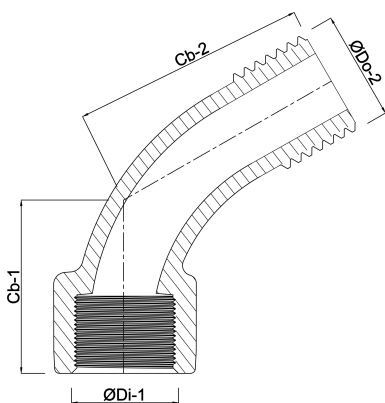

Generiert am: 23.10.2025

Reber Beregnung GmbH
Gottlieb Daimler Str. 2
67227 Frankenthal
32602 VLOTHO-EXTER
Deutschland
+49 (0) 6233 3772 - 0
info@reberberegnung.de
<http://www.reberberegnung.de>



REBER
Bewässerungssysteme