

**Profec Nr. 90 Winkel 90°**  
**Messing 1/2" Innengewinde**  
**30bar (0710286)**



**REBER**  
Bewässerungssysteme

# TECHNISCHE DATEN

Werkstoff	Messing
Anschluss	Innengewinde
Fitting Nr.	Nr. 90
Maß	1/2"
Max. Temperatur	120 °C
Arbeitsdruck	30 bar
Max. Temp.	120 °C

# ABMESSUNGEN

ØDi-1	1/2 "
ØDi-2	1/2 "
F-1	11 mm
F-2	11 mm
Cb-1	23 mm
Cb-2	23 mm
β	90 °



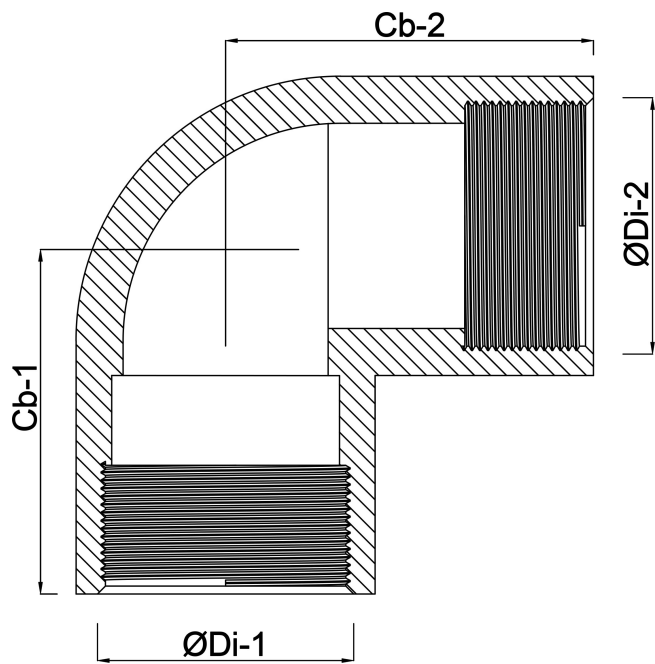

**Generiert am: 05.11.2025**

Reber Beregnung GmbH  
Gottlieb Daimler Str. 2  
67227 Frankenthal  
32602 VLOTHO-EXTER  
Deutschland  
+49 (0) 6233 3772 - 0  
[info@reberberegnung.de](mailto:info@reberberegnung.de)  
<http://www.reberberegnung.de>



**REBER**  
Bewässerungssysteme